

L2462

■ Features of L2462 Series

- 24 characters × 2 lines
- STN gray type LCD is used
- 5 × 7 dot matrix + cursor
- 1/16 duty
- 5V single power supply

■ Specification

A. Mechanical Characteristics

Item	Specifications	Unit
Module size (H×V×T) (Reflective type)	118.0×36.0×11.3	mm
Module size (H×V×T) (Built-in LED backlight type)	118.0×36.0×15.8	mm
Viewing area (H×V)	94.5×17.8	mm
Character size (5×7 dot, H×V)	3.20×4.85	mm
Dot size (H×V)	0.60×0.65	mm
Dot space	0.05	mm
Center to center dimension of mounting holes (H×V)	113.0×31.0	mm
Weight (Reflective type)	40	g
Weight (Built-in LED backlight type)	60	g

H : Horizontal, V : Vertical, T : Thickness (max.)

B. Absolute Maximum Ratings

V_{SS} = 0V

Item	Symbol	Conditions	Min.	Max.	Unit
Power supply voltage	V _{DD}		-0.3	7.0	V
	V _{LC}		V _{DD} -7.0	V _{DD} +0.3	V
Input voltage	V _{IN}		-0.3	V _{DD} +0.3	V
Operating temp.	T _{opr}		0	+50	°C
Storage temp.	T _{stg}		-20	+60	°C
Storage humidity		≤48hrs	+20	+85	%RH
		≤1000hrs	+20	+65	%RH

C. Electrical Characteristics

V_{DD} = 5V ± 5%, V_{SS} = 0V, T_a = 0°C to 50°C

Item	Symbol	Conditions	Min.	Typ.	Max.	Unit
Power supply voltage	V _{DD}		4.75	5.00	5.25	V
	V _{DD} -V _{LC}		3.0	—	6.0	V
Input voltage*	High	V _{IH1}	2.2	—	V _{DD}	V
	Low	V _{IL1}	0	—	0.6	V
Output voltage**	High	V _{OH1}	-I _{OH} = 0.205mA	2.4	—	V
	Low	V _{OL1}	I _{OL} = 1.2mA	—	—	0.4
Current consumption	I _{DD}	T _a = 25°C V _{DD} = 5V V _{LC} = 0.25V	—	2.5	4.0	mA
	I _{LC}		—	0.5	1.0	mA
Clock oscillation frequency	f _{osc}	Resistance oscillation	190	270	350	kHz

* Applied to DB₀ ~ DB₇, E, R_W, RS

** Applied to DB₀ ~ DB₇

D. Optical Characteristics

D-1 Reflective type

Viewing angle : 6 o'clock (∅ = 0°), T_a = 25°C, V_{opr} = 4.75V

Item	Symbol	Conditions	Min.	Typ.	Max.	Unit
Viewing angle	θ ₁	C ≥ 2.0 ∅ = 0°	—	—	-15	deg.
	θ ₂		55	—	—	
	θ ₂ - θ ₁		70	—	—	
Contrast	C	θ = 25°, ∅ = 0°	2	4	—	—
Response time (rise)	t _{on}	θ = 0° ∅ = 0°	—	270	400	ms
Response time (fall)	t _{off}		—	60	100	
Response time (rise)	t _{on}	θ = 0°, ∅ = 0° T _a = 0°C V _{opr} = 5.0V	—	720	1100	ms
Response time (fall)	t _{off}		—	170	350	

D-2 Transflective type

Viewing angle : 6 o'clock (∅ = 0°), T_a = 25°C, V_{opr} = 4.75V, Backlight OFF

Item	Symbol	Conditions	Min.	Typ.	Max.	Unit
Viewing angle	θ ₁	C ≥ 2.0 ∅ = 0°	—	—	-10	deg.
	θ ₂		50	—	—	
	θ ₂ - θ ₁		60	—	—	
Contrast	C	θ = 25°, ∅ = 0°	2	4	—	—
Response time (rise)	t _{on}	θ = 0° ∅ = 0°	—	270	400	ms
Response time (fall)	t _{off}		—	60	100	
Response time (rise)	t _{on}	θ = 0°, ∅ = 0° T _a = 0°C V _{opr} = 5.0V	—	720	1100	ms
Response time (fall)	t _{off}		—	170	350	

E. Recommended Operating Voltage

The recommended value of (V_{opr}) for an ambient temperature is as follows.

V_{opr} = V_{DD}-V_{LC}

Temperature (°C)	0	25	50
V _{opr} (V)	5.00	4.75	4.50

■ **STN Reflective type**

Item	L246200J000
Mechanical Characteristics	A
Absolute Maximum Ratings	B
Electrical Characteristics	C
Optical Characteristics	D-1
Recommended Operating Voltage	E

F-1 Power Supply

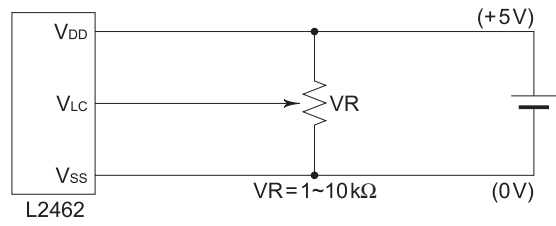

F-2 Dimensions

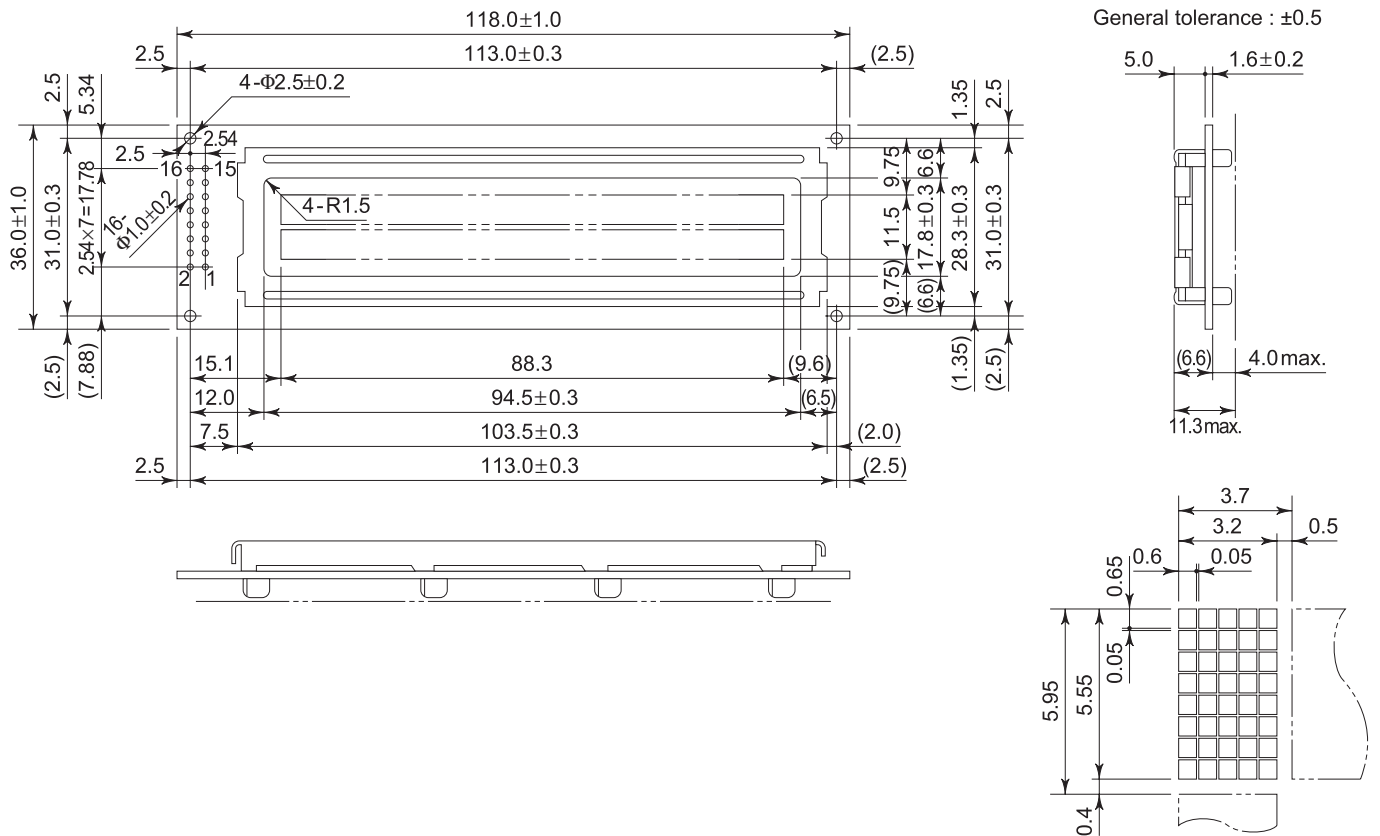

F-3 Pin Functions

No.	Name	Function
1	V _{SS}	GND
2	V _{DD}	Power supply voltage +5V
3	V _{Lc}	Liquid crystal driving voltage
4	RS	L : Instruction code input H : Data input
5	R/W	L : Data write (LCM ← MPU) H : Data read (LCM → MPU)
6	E	Enable
7	DB ₀	Data bus line
8	DB ₁	Data bus line
9	DB ₂	Data bus line
10	DB ₃	Data bus line
11	DB ₄	Data bus line
12	DB ₅	Data bus line
13	DB ₆	Data bus line
14	DB ₇	Data bus line
15	NC	—
16	NC	—

F-4 Block Diagram

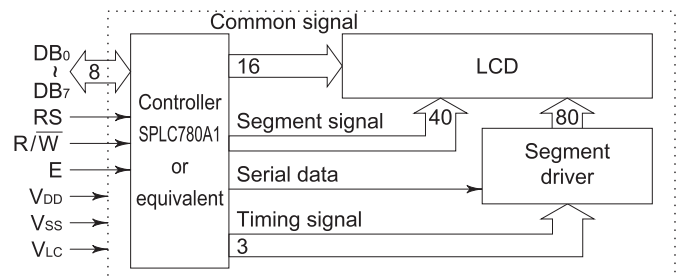

L2462

■ STN Transflective, Built-in LED Backlight type

Item	L2462B1J000
Mechanical Characteristics	A
Absolute Maximum Ratings	B
Electrical Characteristics	C
Optical Characteristics	D-2
Recommended Operating Voltage	E

G-1 Power Supply

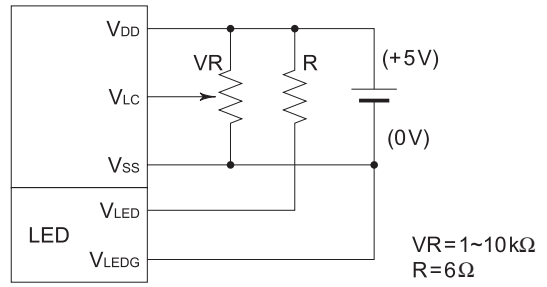

G-2 Dimensions

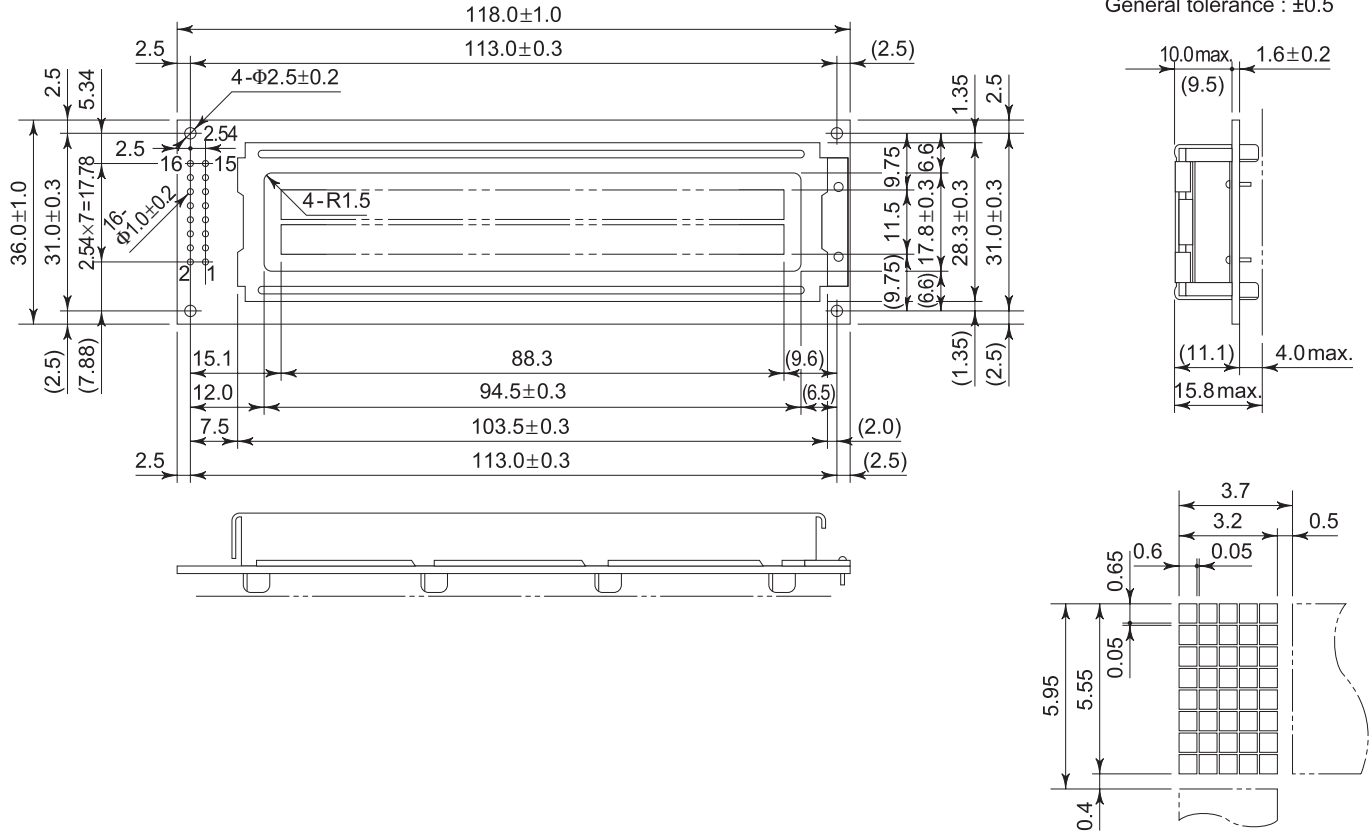

G-3 Pin Functions

No.	Name	Function
1	VSS	GND
2	VDD	Power supply voltage +5V
3	VLC	Liquid crystal driving voltage
4	RS	L : Instruction code input H : Data input
5	R/W	L : Data write (LCM ← MPU) H : Data read (LCM → MPU)
6	E	Enable
7	DB ₀	Data bus line
8	DB ₁	Data bus line
9	DB ₂	Data bus line
10	DB ₃	Data bus line
11	DB ₄	Data bus line
12	DB ₅	Data bus line
13	DB ₆	Data bus line
14	DB ₇	Data bus line
15	VLED	Anode
16	VLEDG	Cathode

G-4 Block Diagram

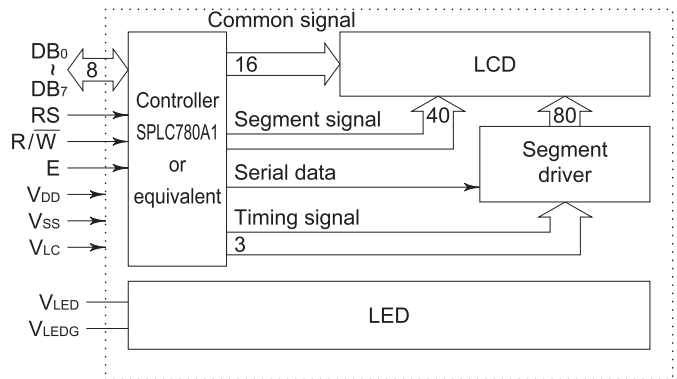

G-5 LED Backlight

G-5-1 LED Circuit Diagram

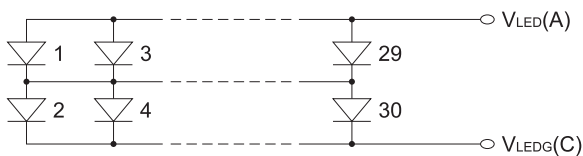

G-5-2 Absolute Maximum Ratings

T_a = 25°C

Item	Symbol	Specifications	Unit
LED forward current consumption*	I _F	300	mA
LED reverse voltage	V _R	8	V
LED allowable dissipation	P _D	1.3	W

* LED forward current consumption and operating temperature characteristics are as follows.

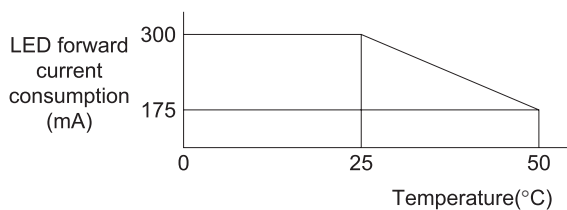

G-5-3 Electrical Characteristics

T_a = 25°C

Item	Symbol	Conditions	Min.	Typ.	Max.	Unit
LED forward input voltage	V _F	I _F = 150mA	3.8	4.1	4.4	V
LED reverse current	I _R	V _R = 8V	—	—	1.5	mA

G-5-4 Optical Characteristics

T_a = 25°C

Item	Symbol	Conditions	Specifications	Unit
Surface brightness (panel upper side)	B _p	I _F = 150mA V _{opr} = 0V	8 min. 10 typ.	cd/m ²
LED brightness	L	I _F = 150mA	40 min. 50 typ.	cd/m ²
LED service life			50,000 typ.	h
LED color			Yellowgreen	